



SYGMA



INSTRUCTION MANUAL DIGITAL ELECTRONIC RADIATOR

Information, operation & installation

ECODESIGN

ACHIEVES & EXCEEDS ALL EFFICIENCY REGULATIONS

WWW.ECODESIGNHEATING.COM

LOT
20
READY

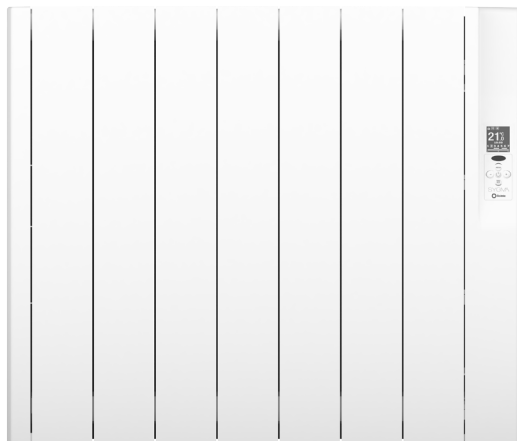

OPTIMIZER[®]
energy plus

INFRARED CONTROL



CE

EAC





Contents:

1. Product information and operation	2
1.1. Control panel	2
1.2. Switching on and off (stand-by)	4
1.3. Adjust the day and time	4
1.4. Adjust the temperature	4
1.5. Lock the control panel	4
1.6. Adjust the display backlight brightness.....	4
1.7. MANUAL / AUTOMATIC functions.....	5
1.8. OPEN WINDOWS function.....	6
1.9. Optimizer Energy Plus technology	7
2. Installation and mounting	7
3. Maintenance and cleaning	9
4. Installation and safety precautions	9
5. Rointe Product Guarantee.....	10
6. European Directive.....	12
7. Dimensions & Technical Characteristics	12
8. Certificate of Guarantee.....	13

1. Product information and operation

1.1. Control panel

1.1.1. Keypad

ICON	DESCRIPTION
	On / Off button Accept / Confirm button
	Decrease temperature button Move left button
	Increase temperature button Move right button
	Menu button Move upwards button
	MANUAL / AUTOMATIC button Move downwards button







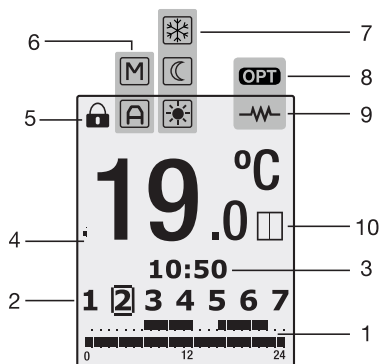



1.1.2. Display panel

NO.	DESCRIPTION
1	Programming
2	Days of the week
3	Time of day
4	Temperature selected
5	Control panel locked / unlocked
6	MANUAL / AUTOMATIC function indicator
7	COMFORT / ECO / ANTI-FROST mode indicator
8	Optimizer Energy Plus technology indicator
9	Heating element active indicator
10	OPEN WINDOWS function indicator



1.1.3. Symbol information











SYMBOL	DESCRIPTION	SYMBOL	DESCRIPTION
	OPEN WINDOWS function - active		AUTOMATIC function active
	Heating element active		MANUAL function active
	COMFORT mode active		Optimizer Energy Plus technology active
	ECO mode active		Control panel locked through keypad
	ANTI-FROST mode active		

1.2. Switching on and off (stand-by)







To switch the product on, please press the  button once. After 5 seconds the temperature, time and days of the week will be show on the display panel.

To switch the product off, please press the  button again once. The product will go into stand-by mode with the word 'STAND-BY' displayed on the display panel.





1.3. Adjust the day and time

To adjust the day and time, please ensure you are in MANUAL function (see section 1.7.) Then press and hold the  button on the keypad for 3 seconds. Use the buttons  and  to set the hour, then press  to confirm. Then use the  and  buttons to set the minutes and press  to confirm. Finally, use the  and  buttons to set the day (1 = Monday, 2 = Tuesday etc.) and confirm by pressing the  button. You will then return to the main display panel.





1.4. Adjust the temperature

To change the temperature, please press the  or the  button. To decrease the temperature press the  button and to increase the temperature press the  button. When the room temperature is lower than the set temperature on the display panel, the product will come on with the  symbol appearing in the top right of the display panel. When the Optimizer Energy Plus technology is activated the symbol **OPT** will replace the symbol  in the top right of the display panel. To learn more about Optimizer Energy Plus please see section 1.9.





1.5. Lock the control panel

To lock the keypad manually, please hold and press the  button AND the  button TOGETHER for 3 seconds. The  symbol will appear on the display panel and the keys will not respond. To unlock the keypad manually, please hold and press the  button AND the  button TOGETHER for 3 seconds.

1.6. Adjust the Display Panel brightness

To change the brightness of the display panel you must be in MANUAL function (see section 1.7). Press and hold the  button for 3 seconds. Then with the buttons  and  you can switch between the two options for the display panel brightness. With the buttons  and  you can increase or decrease the brightness as you wish. The cursor indicates the intensity of the light. Once you have set the required brightness do not touch any buttons on the keypad for 10 seconds and you will return to the main display.

1.7. MANUAL/AUTOMATIC functions

To change or choose the MANUAL or AUTOMATIC function, press the  button on the keypad. You can change from AUTOMATIC to MANUAL and vice versa by pressing the  button again. On the display panel, the symbol  will appear for the AUTOMATIC function and the symbol  for the MANUAL function.

MANUAL	AUTOMATIC
This function allows you to change the product between the COMFORT, ECO and ANTI-FROST modes and to change the temperature.	This function will activate the programming that has previously been set in the product.



1.7.1 MANUAL function

This function enables you to choose between the COMFORT, ECO and ANTI-FROST modes of your product. Here you can adjust the temperature of these modes.

COMFORT	ECO	ANTI-FROST
From 20°C to 30°C	From 15°C to 19.5°C	8°C

To adjust the temperature when in MANUAL function see section 1.4. The icons for COMFORT, ECO and ANTI-FROST will appear when the temperature is changed to the ranges above.

1.7.2 AUTOMATIC function

To program the AUTOMATIC function, see section 1.7. to put the product into AUTOMATIC function. Then press and hold the button for 3 seconds to begin programming.

- STEP 1 - Select COMFORT mode temperature

COMFORT mode will be programmed first. Select the COMFORT mode temperature between 20°C and 30°C using the and buttons. The icon and the temperature will flash. Press the button to confirm.

- STEP 2 - Select ECO mode temperature

ECO mode will be programmed next. Select the ECO mode temperature between 15°C and 19.5°C. The icon and the temperature will flash. Press the button to confirm.

- STEP 3 - Select the Days

The days of the week will start flashing on the display panel and show as DAY 1, DAY 2, DAY 3 etc. Use the and buttons to move forwards or backwards through the days. Press to select the day or days that you wish to include in your AUTOMATIC program. The day will stop flashing once selected. Repeat for all the days you wish to program with the same settings and once all days are selected press the button to move onto setting the hour.



- STEP 4 - Select the Hours

Once step 3 has been completed, 0h appears on the display panel. 0h is equal to the time, midnight. Use the or buttons to select the hour you wish to change. Use the button to change the mode (COMFORT, ECO or ANTI-FROST) for the hour you wish to modify for all the days selected in step 3. The corresponding icon for that mode will appear at the top of the screen.

To finish the programming press or leave for 30 seconds without pressing any buttons. To change the programming go back to step 1 and proceed as described before.

*If you wish to have individual days with different programming within your program you will need to modify each day separately, starting from the Main Menu again for each day/days. Follow Steps 1 to 4 above to program multiple differing days/hours/temperatures.

1.8. OPEN WINDOWS function

This function is activated when the temperature sensor detects a drop of 4°C from the set temperature within a 30 minute time period. The OPEN WINDOWS function will be active for 2 hours. If the  button is pushed during this period the product will switch off. Pushing the button  again will switch on the product without the OPEN WINDOWS function being switched on.

When this function is activated by the sensor, the following image will appear on the product display panel for 5 seconds:



When the OPEN WINDOWS function is activated, the product will move into ANTI-FROST mode at 8°C. The ❄️ icon will appear on the product display panel showing that the ANTI-FROST mode is active.

1.9. Optimizer Energy Plus technology

Optimizer Energy Plus is a technology developed by Rointe that bases its operation on thousands of micropulses being sent to the product to keep a stable temperature with a consumption as low as possible. When the  icon on the display panel is replaced with the **OPT** icon on the display panel, then the Optimizer Energy Plus technology has been activated and is working.

2. Installation and mounting

2.1. Mounting instructions

The product must never be installed directly below a power point. In bathrooms, the product must never be installed where the switches and/or other products may be within the reach of someone in the shower or bathtub.

The product works using natural air convection (Figure 1). In order to achieve optimal performance and an even distribution of heat, the product must be positioned according to the following table (Table 1). See Figure 2 for positioning.

Table 1:

PRODUCT PART	MINIMUM (cm)	MAXIMUM (cm)
	DISTANCE FROM FLOOR / WALL / BRICKWORK	
Lower	10 - 12	30
Sides	10 - 12	-
Upper	10 - 12	-



Figure 1:

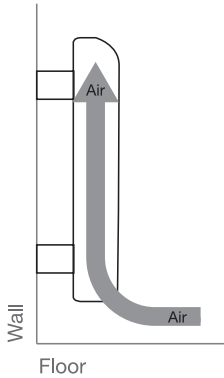
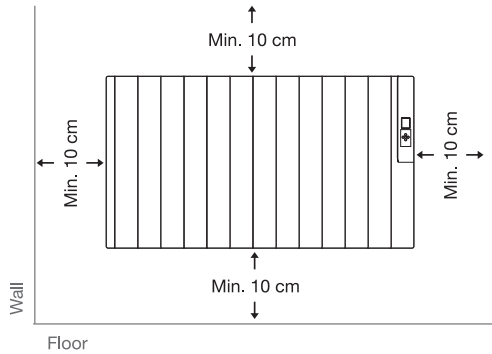

Figure 2:



2.2. Installation and fixing the supports

Inside the product packaging you will find a fixing kit so you can mount the product to the wall. Please follow these instructions carefully.

<p>Choose the right part of the wall (see section 2.1. for minimum distance from wall).</p> <p>Place the mounting stencil on the wall, marking the places for the holes.</p>	<p>Once you have marked the holes, remove the stencil and make the holes in the wall.</p> <p>Fix the supports using the plugs and screws provided (or others suitable for the wall type).</p>	<p>Check the positioning is correct of the lower support.</p> <p>Align the product with the top supports.</p> <p>Once aligned, place the product in the supports.</p>

Installing Template measurements dependent on the model:

SRI0330RAD2

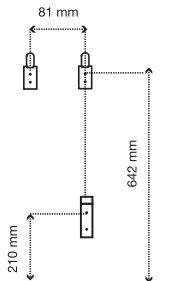

Floor

SRI0550RAD2

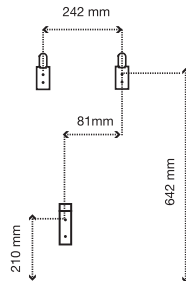

Floor

SRI0770RAD2

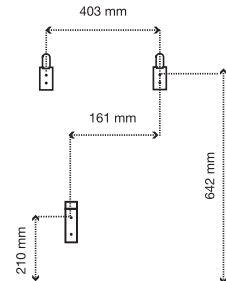

Floor

SRI0990RAD2

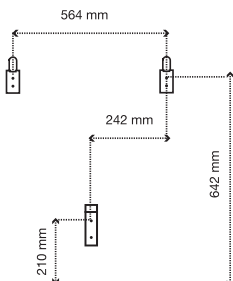

Floor

SRI1210RAD2

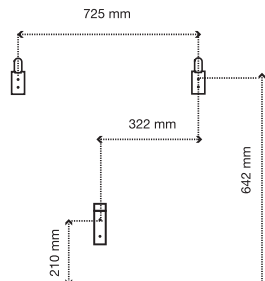

Floor

SRI1430RAD2 / SRI1600RAD2

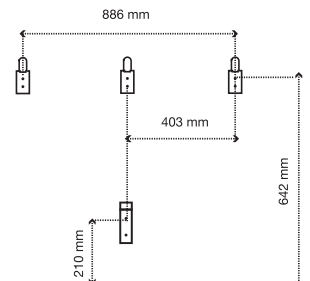

Floor

3. Maintenance and cleaning

The product does not require any type of regular maintenance. However, we recommend that all parts of the product are kept clean (behind, underneath, along the upper fins etc.). Do not use any abrasive product on the aluminium. Clean the aluminium with a damp cloth and a pH neutral soap. Clean the control panel with a dry cloth.

4. Installation and safety precautions (EN 60335 Standards)

Before switching on the product, please read the "Installation & Safety Precautions" in detail first to ensure the correct operation of the product.

4.1. Installation precautions

The product is designed for household or residential use only. You are advised to have the product installed by an authorized professional installer. Please contact Rointe by telephoning 0203 321 5928 to find your nearest installer. Make sure the product is properly connected to 230V and is earthed.



4.2. Safety precautions

The product can be used by children aged from 8 years and above and by persons with reduced physical sensory or mental capabilities or lack of experience and knowledge, if they are supervised or have been given instruction concerning use of the product in a safe way and understand the hazards involved. The product is not a toy, children should not play with the product. Cleaning and user maintenance should not be carried out by children without supervision. Children must be supervised at all times to ensure that they do not interfere with the product.

The product is filled with a precise amount of special thermal oil that does not need or require any maintenance. Any repairs requiring the opening of the oil tank must only be done by ROINTE or its official after-sales service personnel, who should also be notified should an oil leak be noticed. The regulations on discarding oil when the heater is being disposed of must be observed. If the power cable is damaged, it must be replaced by the manufacturer, its after-sales service or authorized personnel in order to avoid any damage.

WARNING - In order to avoid overheating, do not cover the product. Do not insert any kind of object in the air vents. Never use with wet hands. Do not place any containers with water, such as glasses or vases etc. on or near the product. Do not use insecticides, paints or aerosols on or near the product. Do not sit on the product or place anything in front of it.

5. Rointe Product Guarantee

In this section, we hereby describe the guarantee conditions, which the buyer acquires, on buying this product from ROINTE. These conditions comply with all the rights construed in the national legislation in force, as well as any additional rights and guarantees, which are offered by ROINTE.

Any incident that you might detect in your ROINTE product can be sorted by the product seller or quickly by the manufacturer. Please **contact ROINTE by telephoning 0203 321 5929 for Technical Support**. Alternatively, you can **email ROINTE at support@rointe.co.uk**, through which we will instruct you on how to solve the incident.

You will need to state the product reference (located on the label indicating product features), serial number, proof of purchase and the type of incident at hand when contacting us so that we can check the guarantee. In addition, please attach a copy of the product invoice.

REFERENCE	TCOD: RS6154311		
	REF: SRI1100RAD2		
	INPUT: 230 V~ 50Hz 1,100W		
SERIAL NUMBER	S/N: 8436045914897000001		
	SYGMA		

5.1. ROINTE guarantees that there are no material defects of design or manufacture at the time of original acquisition and guarantees the aluminium body for a period of 120 months and any electronic and electrical components for 24 months, provided that they have not been modified in any way.

5.2. If during the guarantee period, the product does not work correctly under normal use, and any design, material or manufacturing defect is found, ROINTE will repair or substitute the product as it may see fit, in accordance with the terms and conditions as follows:

5.2.1. The guarantee is only applicable if the original guarantee is issued by the seller and when the said guarantee is filled in correctly including product reference, series number (marked on the product's label indicating technical features), purchase date and the seller's stamp, and either registered on our website at www.rointe.co.uk or returned completed to ROINTE within 90 days of installation. ROINTE reserves the right to reject the guarantee service when this information has been removed or modified after the original product purchase.

5.2.2. The guarantee is only applicable if the product has been installed by a competent person in accordance with this installation manual and all current regulations and codes of practice at the time of installation.

5.2.3. The guarantee is only applicable to those cases that concern material, design and manufacturing defects, and under no circumstances covers damage to the product for the following reasons:

5.2.3.1 Damage caused by negligence and/or misuse of the product, i.e. used for other purposes that are not construed as its normal use or for not respecting the instructions of use and maintenance given by ROINTE as well as incorrect installation or use of the product that may not comply with the current technical standards of safety.

5.2.3.2. Corrosion of any part of the product caused by direct exposure to salt water. When the product is installed no more than 200m from the coast the guarantee for damages caused by corrosion the period will be reduced by 50%.

5.2.3.3. Any unauthorised modification of the product or repairs of the product carried out by third parties or unauthorised technicians or opening of the product by third parties or unauthorised people.

5.2.3.4. Any accidents that are deemed outside the control of ROINTE, such as (but not limited to): lightning, fires, floods, natural disasters, public disorder, atmospheric or geologic phenomena etc.

5.2.3.5. Faults that result from an incorrect installation. Guidance can be found within the recommendations for installation, by Rointe and in the installation manual. If in doubt, please contact ROINTE.

5.2.4. Any repairs or substitutions that are included in this guarantee do not allow any additions or new periods of guarantee.



5.2.5. Any repairs or substitutions covered under this guarantee must be parts that are functionally equivalent. The defective parts or parts removed or replaced shall become the property of ROINTE.

5.2.6. The product must be installed in a way that allows access for our technicians should they need to gain access to the product for repair or maintenance. The user/client is responsible for any costs or organisation required to provide access to the products for their repair and/or substitution.

5.3. The Technical Service department of ROINTE will advise you if you need to purchase any parts not covered under the guarantee or out of guarantee.

5.4. This guarantee will be null and void if the product: has been manipulated, modified and/or repaired in any way and/or by unauthorised persons. This guarantee will also be void if the product is not correctly installed.

5.5. This guarantee is not transferable and does not include claims due to frost or limescale damage.

5.6. Proof of purchase will be required to ROINTE for any claim.

5.7. This guarantee does not affect your statutory rights.

5.8. This guarantee does not affect the buyer's legal rights stipulated in the current national legislation, nor affects those rights against the distributor or installer that could come forth in compliance with the purchase contract.

5.9. In the absence of a national legal legislation applicable, this guarantee shall prevail and may be construed as the buyer's only protection. ROINTE, its offices, distributors and installers may not be held responsible for any accidental damage that emerges due to infringement of any rules implicitly related to this product.

For help about the product or guarantee, please **contact ROINTE by telephoning 0203 321 5929 for Technical Support** or by **email to support@rointe.co.uk**.

6. European Directive (WEEE) 2012/19/UE

Under the European Directive 2012/19/UE on Waste Electrical and Electronic Equipment (WEEE), the product cannot be disposed in the usual council bins and containers. They must be separated to optimize the recovery and recycling of all of the components and materials and reducing the impact to human health and the environment. The symbol of the container crossed out over a horizontal line is marked on all of ROINTE products to remind the consumer of the obligation to separate them on disposal. The consumer should contact the local authority or original point of sale to learn more about the correct disposal of this product.

7. Dimensions & Technical Characteristics

MODEL	SRI0330RAD2	SRI0550RAD2	SRI0770RAD2	SRI0990RAD2	SRI1210RAD2	SRI1430RAD2	SRI1600RAD2
No. Elements	3	5	7	9	11	13	15
DIMENSIONS							
Width (mm)	345	505	667	827	1,010	1,180	1,330
Height (mm)	575	575	575	575	575	575	575
Depth (mm)	98	98	98	98	98	98	98
Installed Depth (mm)	120	120	120	120	120	120	120
WEIGHTS & FINISHES							
Weight (kg)	8	12	16	20	24	28	32
Finish	White RAL-9010						
ELECTRICAL CHARACTERISTICS							
Nominal Power (W)	330	550	770	990	1,210	1,430	1,600
Effective Power (W)	132	220	308	396	484	572	640
Voltage (V)	230 ~V	230 ~V	230 ~V	230 ~V	230 ~V	230 ~V	230 ~V
Current (A)	1.5	2.4	3.4	4.3	5.3	6.2	7.0
Power per Elem.(W/Element)	110	110	110	110	110	110	110
PERFORMANCE & SECURITY							
Safety thermostat	✓	✓	✓	✓	✓	✓	✓
Protection Grade	IP21	IP21	IP21	IP21	IP21	IP21	IP21
INSTALLATION							
Template & Installation Kit	✓	✓	✓	✓	✓	✓	✓
EAN CODES	8436045914828	8436045914835	8436045914842	8436045914859	8436045914866	8436045914873	8436045914880

Cut along the dotted line



CERTIFICATE OF GUARANTEE



In the event of any defect being detected in the product within the period of guarantee, you must fill in the below Certificate of Guarantee and send it to us stamped together with a copy of the sales invoice via email to support@rointe.co.uk or to the following postal address: INDUSTRIAS ROYAL TERMIC, S.L., C/E, Parcela 43, 30140 Santomera (Murcia, Spain).

CERTIFICATE OF GUARANTEE	
REFERENCE:	N° SERIES: PURCHASE DATE:
USER:	
HOME ADDRESS:	
TOWN:	POSTCODE:
COUNTY:	COUNTRY:
TELEPHONE:	EMAIL:
SELLER'S STAMP:	

NB: This certificate of Guarantee MUST be completed in full in order to obtain guarantee rights. The purchase date and seller's stamp are compulsory. Please attach a copy of your sales invoices. In addition, for new constructions include the Certificate of First Occupation.



Thank you for choosing Rointe. We hope you enjoy your product.

If you require further assistance or information, please contact our Technical Service Department by telephoning **0203 321 5929** or email **support@rointe.co.uk**.



ROINTE UK

Catalyst House,
720 Centennial Court, Centennial Park
Elstree, Herts, WD6 3SY

T. 0203 321 5928

F. 0208 953 5861

Technical Support

T. 0203 321 5929

E: support@rointe.co.uk

www.rointe.co.uk