



SYGMA

short

INSTRUCTIONS MANUAL

SYGMA DIGITAL ELECTRIC RADIATOR

EN

MOUNTING, INSTALLATION,
STARTING AND OPERATION

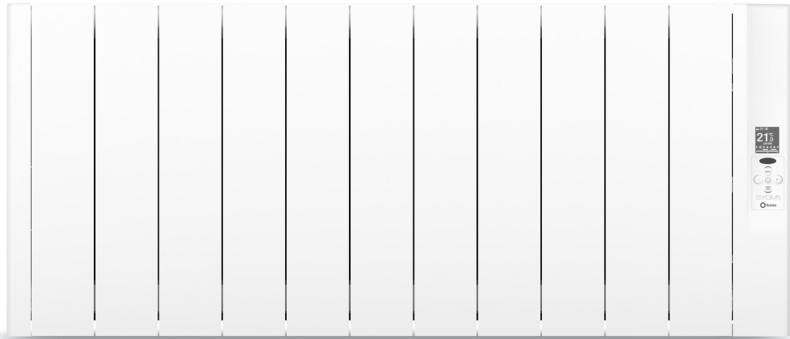

INFRARED CONTROL



WELCOME

Dear Customer,

Thank you for choosing the low consumption SYGMA short digital electric radiator, with an exclusive electronic temperature programmer and made with the highest quality materials especially for you.

The low consumption SYGMA short digital electric radiators have exceeded the most stringent quality controls in order to comply with the most rigorous requirements for safety and energy efficiency requirements.

Thanks to the OPTIMIZER ENERGY PLUS technology, exclusive to the ROINTE SYSTEM, the low consumption SYGMA short digital electric radiators achieve the maximum energy saving.

Before using the low consumption SYGMA short digital electric radiator, we recommend that you read this instruction manual in order to ensure correct operation.

IMPORTANT
THIS MANUAL SHOULD BE LEFT WITH THE PRODUCT AFTER
INSTALLATION



ENGLISH

ATTENTION:

If you are the owner of a model bought in the UK or Éire, please refer **ONLY** to its manual as the specifications of the radiators are different.

TABLE OF CONTENTS

1. DESCRIPTION OF THE “SYGMA SHORT” RADIATOR	4
1.1. Front Panel Parts	4
1.2. Switching On & Off (stand-by)	6
1.3. Setting the Day and Time	6
1.4. Locking the Control Panel	6
1.5. Temperature Selection.....	7
1.6. Manual/Automatic Functions	7
1.7. Menu/Programming Function	8
1.8. Open Window Function	8
1.9. Optimizer Energy Plus Function.....	9
1.10. Screen Brightness Function.....	9
2. INSTALLATION & MOUNTING	10
2.1. Mounting	11
2.2. Fixing the supports	11
3. MAINTENANCE & CLEANING	13
4. INSTALLATION & SAFETY PRECAUTIONS (EN 60335 STANDARDS) ...	13
4.1. Installation precautions.....	13
4.2. Safety precautions	14
5. GUARANTEE	15
6. SYGMA SHORT RADIATORS TECHNICAL CHARACTERISTICS.....	19

1. DESCRIPTION OF THE SYGMA SHORT RADIATOR

1.1. Front panel parts

TFT DISPLAY

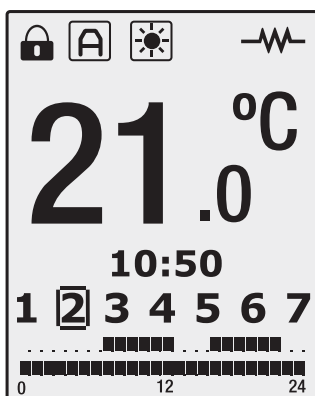

CONTROL PANEL





1.1.1. TFT display symbols

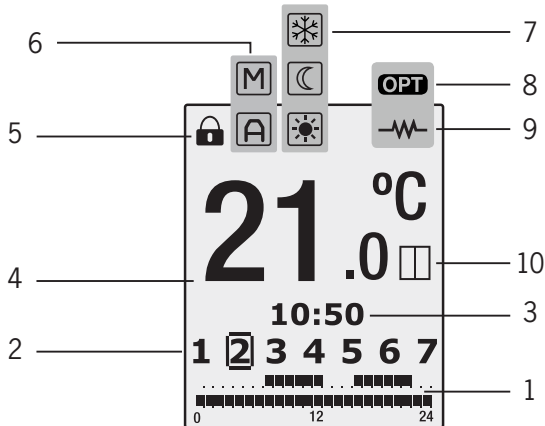

NUM.	FUNCTION
1	PROGRAMMING
2	DAYS OF THE WEEK
3	TIME OF DAY
4	TEMPERATURE SELECTED
5	LOCKING THE CONTROL PANEL
6	MANUAL / AUTOMATIC FUNCTION
7	COMFORT / ECO / ANTI-FROST MODE
8	OPTIMIZER ENERGY PLUS FUNCTION
9	HEATER ELEMENT ON
10	OPEN WINDOW FUNCTION

1.2. Switching On & Off (stand-by)

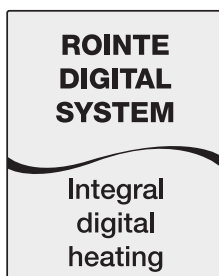

By pressing the key , we can switch the radiator on or off. The following image will appear on the screen when switched on:



The screen will automatically go into sleep mode if no button is pushed for 10 seconds. By pushing the button again the radiator will go into standby mode with the word "Standby" appearing followed by the Rointe logo.



1.3. Setting the day and time

By pressing the button  for 3 seconds, we can access the time and date adjust feature to adjust the time and date of our radiator.

Pressing the button , flashes up the hours, minutes and days of the week according to the number of times it is pressed. With the buttons  and  we can alter the current settings.

To leave the time and date adjust feature, wait 30 seconds or press  after the date select.

1.4. Locking the control panel



By pressing the keys  and , at the same time for 3 seconds, we lock the control panel. The  control panel symbol is activated and the keys will not respond when pressed. The following symbol will appear on the screen if any button is pushed:







To unlock, press the  and  keys again, at the same time for 3 seconds.

1.5. Temperature selection

By pressing  or  we change the temperature. When the room temperature is lower than the one set, the heating element comes on and the  symbol appears.



1.6. Manual/Automatic functions

By pressing  we change between the Manual and Automatic functions.

When the Manual function is selected, the symbol  appears on the display. When the Automatic function is selected, the symbol  appears on the display.

1.6.1. Manual function

This enables you to choose between the COMFORT, ECO and ANTI-FROST modes of operation, changing the temperature as indicated in Section 1.5.

















ICON	MODE	TEMPERATURE RANGE
	COMFORT	20°C – 30°C
	ECO	15°C – 19.5°C
	ANTI-FROST	8°C

1.6.2. Automatic function

This mode activates the programming set on the radiator.

1.7. Menu/Programming function

In automatic mode, pressing  for 3 seconds allows you to program the radiator directly:

1. Select the COMFORT temperature setting (20°C to 30°C), using  and . The symbol  and the temperature will flash.
2. Press  and we can select the ECO temperature (15°C to 19.5°C) using  and . The symbol  and the temperature will flash.
3. After pressing the button  once again, the days of the week will start flashing and show as DAY1, DAY2, DAY3... We can go forwards and backwards using the button  and . Press  to select the day or days that we wish to program.
4. Pressing , takes us to the hours we wish to program. To change the hours use the  or  buttons. The hours selected will show as 0h, 1h, 2h,... By pressing the  button, we can select the mode required hour by hour: COMFORT, ECO or OFF.
5. To finish the programming, press  or leave it for 30 seconds without pressing any buttons.

1.8. “Open Window” function

This function is activated when the probe detects a reduction of 4° in respect of the set temperature during 30 minutes. On activation the following image will appear on the radiator display for 5 seconds:





When the “Open window” function is activated, the following screen

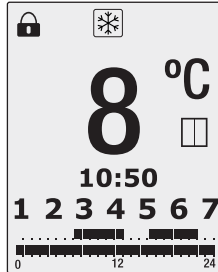

will appear showing that the anti-frost mode is activated:



This function will be active for 2 hours. If the button  is pushed during this period the radiator will switch off. Pushing the button  again will switch on the radiator without the “Open window” function being switched on.

1.9. Optimizer Energy Plus Function

This product includes Optimizer Energy Plus Rointe technology to efficiently manage the energy consumption of the radiator.



Optimizer Energy Plus is a technology that bases its operation on thousands of micropulses being sent to the radiator to keep a stable temperature with a consumption as low as possible.

When the symbol **OPT** replaces the , then the Optimizer Energy Plus technology is working.

1.10. Screen brightness function

You can change the brightness of the screen by pushing the  button for 3 seconds when the product is in manual mode. Entering this mode

you will see the following screen:

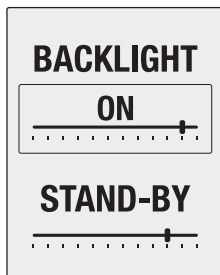

In ON mode you can increase or decrease the brightness of the screen by using the **⊖** and **⊕** buttons.

You can change the “Standby” mode brightness by pushing the button **MAN SET** to move the frame to the “STAND-BY” position. You can then adjust the brightness by pushing the same **⊖** and **⊕** keys.

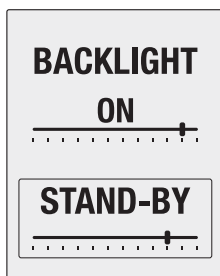

To finish the programming wait for 10 seconds without pressing any buttons.

2. INSTALLATION & MOUNTING

The radiator must never be installed directly below a power point.

In bathrooms, the radiator must never be installed where the switches and other devices may be within the reach of someone in the shower or bathtub.



2.1. Mounting

The SYGMA radiator works by means of natural air convection (Figure 1). In order to achieve optimal functioning and an even distribution of heat, the lower part of the radiator, once mounted on the wall, must be at least 10 to 12 cm from the floor, and 30 cm at the most.

As for the sides and above, a minimum distance of between 10-12 cm must be left from any wall or brickwork in order for it to function correctly (Figure 2).

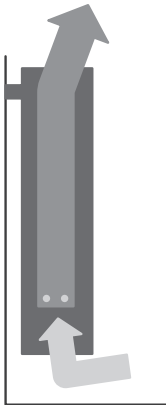

Fig. 1

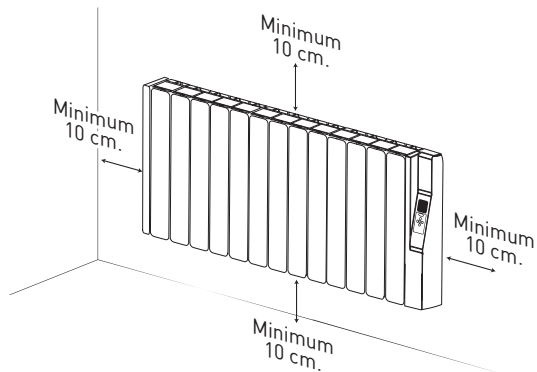

Fig. 2

2.2. Fixing the supports

Inside the packaging you will find a fixing kit.

- Choose the right part of the wall.
- Place the mounting stencil on the wall, marking the places for the holes.
- Remove the stencil and make the holes in the wall.

- Fix the supports using the plugs and screws provided or others suitable for the wall type.
- Check the correct positioning of the lower support.
- Align the radiator with the top supports.
- Place the radiator on the supports.

Installing template measurements depending on the model:

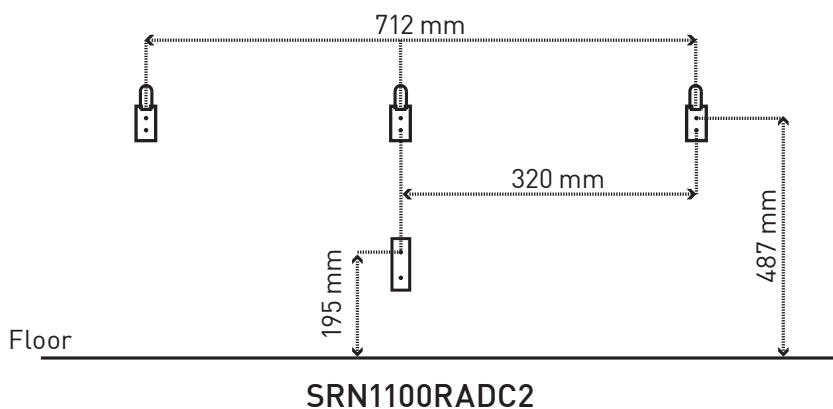

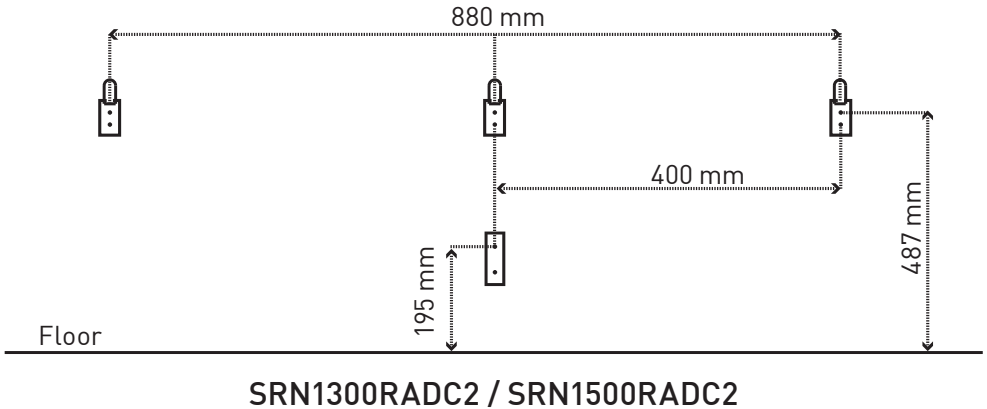

3. MAINTENANCE & CLEANING

The radiator does not require any type of maintenance. We recommend that all parts of the radiator are kept clean (behind, underneath, upper fins, etc.). Do not use any abrasive product on the aluminium. Clean it with a damp cloth and a pH neutral soap, and the stencil with a dry cloth.

4. INSTALLATION & SAFETY PRECAUTIONS (EN 60335 STANDARDS)

Before switching on the radiator, please read the “Installation & Safety Precautions” in detail first to ensure the correct operation of the radiator.

4.1. Installation precautions

The radiator is designed for household or residential use. You are advised to have the radiator installed by an authorized professional

installer. Make sure the radiator is properly connected to 230V and is earthed.

4.2. Safety precautions

This appliance can be used by children aged from 8 years and above and persons with reduced physical sensory or mental capabilities or lack of experience and knowledge if they are supervised or have been given instruction concerning use of the appliance in a safe way and understand the hazards involved. Children should not play with the appliance. Cleaning and user maintenance should not be carried out by children without supervision. Children must be supervised at all times to ensure that they do not play with the product.

This radiator is filled with a precise amount of special oil that does not need any maintenance. Any repairs requiring the opening of the oil tank must only be done by ROINTE or its after-sales service personnel, who should also be notified should an oil leak be noticed. The regulations on discarding oil when the heater is being disposed of must be observed. If the power cable is damaged, it must be replaced by the manufacturer, its after-sales service or authorized personnel in order to avoid any damage.

WARNING! In order to avoid overheating, don't cover the heater. Don't insert any kind of object in the air vents. Never use with wet hands.

Don't place any containers with water, such as glasses, vases, etc. on the radiator. Don't use insecticides, paints or aerosols on the radiator. Don't sit on the radiator or place anything in front of it.

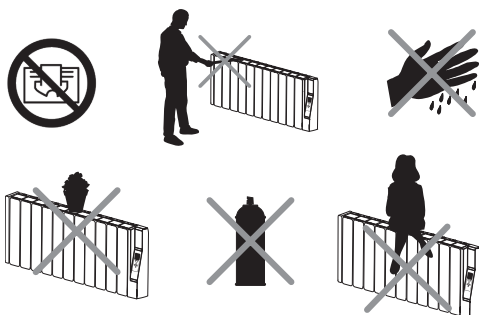



5. GUARANTEE

In this section, we hereby describe the guarantee conditions which the buyer acquires on buying a new radiator of Rointe brand. These conditions comply with all the rights construed in the national legislation in force, as well as any additional rights and guarantees which are offered by Rointe brand.

5.1. Any incident that you might detect in your Rointe radiator can be sorted by the product seller or quickly by the manufacturer. Rointe provides a contact telephone for any technical support **01432 598 024** or the following email address **support@rointe.co.uk**, through which we will instruct you on how to solve the incident.

You will need to state the product reference (located on the label indicating product features), serial number, proof of purchase and the type of incident at hand when contacting us so that we can check the guarantee. In addition, please attach a copy of the product invoice.

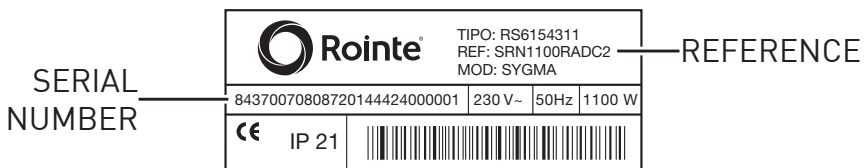

5.2. Rointe guarantees that there are no material defects of design or manufacture at the time of original acquisition and guarantees the aluminium for a period of 120 months and 24 months for any electronic and electrical components.

5.3. If during the guarantee period, the product does not work correctly under normal use or any design, material or manufacturing defect is

found, ROINTE will repair or substitute the radiator as it may see fit in accordance with the terms and conditions as follows:

5.3.1. The guarantee is only applicable if the original guarantee is issued by the seller and when the said guarantee is filled in correctly including product reference, series number (marked on the product's label indicating technical features), purchase date and the seller's stamp.

ROINTE reserves the right to reject the guarantee service when this information has been removed or modified after the original product purchase.

5.3.2. The guarantee only applies to those cases that concern material, design and manufacturing defects, and under no circumstances covers damage to the radiator for the following reasons:

a) Incorrect use of the product, i.e. used for other purposes that are not construed as its normal use or for not respecting the instructions of use and maintenance given by Rointe as well as incorrect installation or use of the product that may not comply with the current technical standards of safety.

Corrosion caused by direct exposure to salt water is excluded from the guarantee. When the product is installed no more than 200m from the coast the guarantee for damages caused by corrosion the period will be reduced by 50%.

b) Any unauthorised repairs carried out by unauthorised technicians or opening of the radiator by unauthorised people.

c) Any accidents that are deemed outside the control of Rointe, such as lightning, fires, floods, public disorders, etc.



5.3.3. Any repairs or substitutions that are included in this guarantee do not allow any additions or new periods of guarantee.

5.3.4. Any repairs or substitutions covered under this guarantee must be parts that are functionally equivalent. The defective parts or parts removed or replaced shall become the property of Rointe.

5.4. The technical service of Rointe will advise you if you need to buy any parts not covered under the guarantee or out of guarantee.

5.5. This guarantee does not affect the buyer's legal rights stipulated in the current national legislation, nor affects those rights against the distributor or installer that could come forth in compliance with the purchase contract.

5.6. In the absence of a national legal legislation applicable, this guarantee shall prevail and may be construed as the buyer's only protection. Rointe, its offices, distributors and installers may not be held responsible for any accidental damage that emerges due to infringement of any rules implicitly related to this product.

European Directive (WEEE) 2012/19/EU

Under the European Directive 2012/19/EU on waste electrical and electronic equipment (WEEE), the apparatus cannot be disposed in the usual council bins and containers. They must be separated to optimize the recovery and recycling of all of the components and materials and reducing the impact to human health and the environment. The symbol of the container crossed out over a horizontal line is marked on all of ROINTE's products to remind the consumer of the obligation to separate them on disposal.

The consumer should contact the local authority or original point of sale to learn more about the correct disposal of this product.

6. SYGMA SHORT RADIATORS TECHNICAL CHARACTERISTICS

MODEL	NUMB. OF ELEM.	POWER	VOLTAGE	HEIGHT (mm)	WIDTH (mm)	DEPTH (mm)	INST. DEPTH (mm)	WEIGHT
SRN1100RADC2	11	1,100 W	230V~	420	1,010	98	120	19 kg
SRN1300RADC2	13	1,300 W	230V~	420	1,180	98	120	22 kg
SRN1500RADC2	15	1,500 W	230V~	420	1,300	98	120	25 kg

SYGMA *short*



Cut along the dotted line

CERTIFICATE OF GUARANTEE



In the event of detecting any defect in the product within the period of guarantee, you must fill in the following Guarantee Certificate and send it to us stamped together with a copy of the sales invoice via email to support@roointe.co.uk or to the following postal address: INDUSTRIAS ROYAL TERMIC, S.L., C/E, Parcela 43, 30140 Santomera (Murcia, Spain).

For new constructions, it is essential that you attach the Certificate of First Occupation.

CERTIFICATE OF GUARANTEE

REFERENCE:	Nº SERIES:
USER:	
HOME ADDRESS:	
TOWN:	POSTCODE:
PROVINCE:	COUNTRY:
TELEPHONE:	SELLER'S STAMP:
EMAIL:	
	PURCHASE DATE:

NB: This certificate of Guarantee must be filled in out in full in order to obtain guarantee rights. The date of purchase and seller's stamp are compulsory. Please, attach a copy of your sales invoices. In addition, for new constructions include the Certificate of First Occupation.



SYGMA *short*

LOW CONSUMPTION DIGITAL ELECTRIC RADIATOR

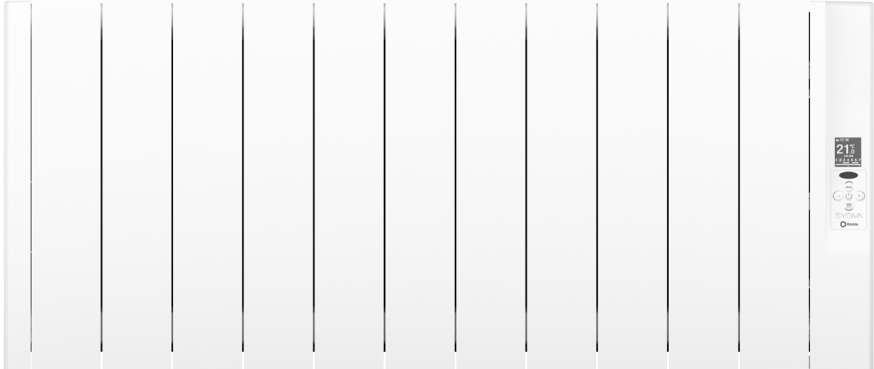



ROINTE UK

Catalyst House 720, Centennial
Court, Centennial Park
Elstree, Herts, WD6 3SY

T. 01432 598 019
F. 0208 953 5861

SUPPORT

T. 01432 598 024

support@rointe.co.uk
www.rointe.co.uk

ROINTE HEAD OFFICE

Pol. Ind. Vicente Antolinos
C/ E, Parcela 43
30140 Santomera, Murcia, España

T. 902 158 049
F. 968 277 125

SERVICIO TÉCNICO

T. 902 130 134

sat@rointe.com
www.rointe.com