



# User Manual

## Belize radiator

Models

**0330RAD | 0550RAD | 0770RAD | 0990RAD | 1210RAD | 1430RAD | 1600RAD**

Please read this manual carefully before installation and operation. Please keep this manual for future reference and your product guarantee conditions.

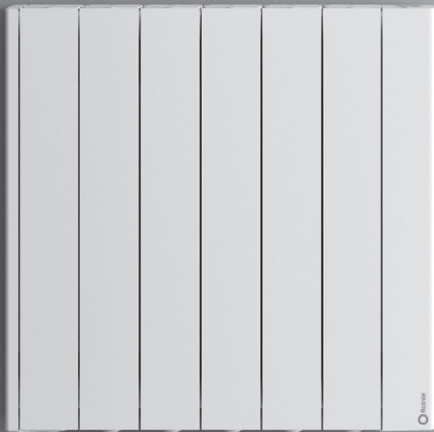
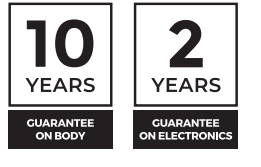

## CONTENTS

1. Introduction .....	2
2. Features & functions .....	4
3. Installation .....	4
4. Control panel .....	8
5. Operation & programming .....	9
6. WiFi pairing .....	17
7. Maintenance and cleaning .....	18
8. European Directive (WEEE) 2012/19/UE .....	18
9. Guarantee .....	18
9.1 Terms and conditions .....	19
9.2 How to register .....	21
10. ERP Directive Commission Regulation (EU) 2015/1188 .....	22
11. Technical specification & data .....	23

## 1. INTRODUCTION

**Thank you for choosing this product. Please read this manual carefully before operation and retain for further use.**

ROINTE digital electric radiators are designed for all types of environments and to meet any thermal need. The careful choice of components and materials ensures efficiency, without affecting comfort.

Using a unique design, ROINTE radiators utilise natural air convection with an air-speed of >0.1 m/s. Cold air is introduced at the bottom of the radiator and raises its temperature by passing through the interior of the heating element and expelling at the top as warm air. This allows a constant room temperature with a small variation of only +/- 0.25°C.

To ensure maximum energy efficiency, ROINTE products must be correctly sized. Please check with your installer or supplier, before installation, that the product you have purchased is the correct size for the room requirements. **ROINTE will not be held responsible for incorrectly sized products, unless an official ROINTE Technical Study has been completed and followed.** We recommend mounting the product on the wall at a height between 10 and 15 cm from the floor. This guarantees optimal natural convection throughout the room.

**IMPORTANT:** When using electrical appliances, precautions should be taken to reduce the risk of fire, electrical shock and injury to persons.

**IMPORTANT:** This product is filled with a precise amount of thermal oil that does not require maintenance. Any repairs that require opening the oil tank must be done by ROINTE or authorized personnel, who should also be notified if an oil leak is noticed. Please observe regulations when disposing of this product and its thermal oil.

**IMPORTANT:** To disconnect the product from the main power supply, remove the plug from the socket. Do not pull the cable.

**WARNING:** If the power cable is damaged, it must be replaced by ROINTE or its authorized personnel in order to avoid any damage.

**WARNING:** Servicing and product repairs should only be undertaken by ROINTE or its authorized personnel using only exact manufacturer-approved spare parts.

**WARNING:** The product is IP24 rated and may be used in bathrooms, however not in the immediate vicinity of baths, showers, water connections, basins, swimming pools or other bodies of water. The product must never be installed where itself or the switches/control panel is within the reach of persons in water. Never use the product with wet hands. Do not place any water containers (glasses, vases etc.) on or near the product.



**WARNING:** To avoid overheating or the interruption of the natural convection cycle, do not cover the product. This includes furniture, curtains, clothes and any other items. Do not insert any kind of object in the product or obstruct its air circulation. Obstructions should not be placed in front, above or directly next to the product. Do not use insecticides, paints, chemicals or aerosols on or near the product. Do not sit on the product. Failure to comply with the above will render your guarantee invalid.

**WARNING:** This product can be used by children aged over 8 years and by persons with reduced physical, sensory or mental capabilities, or lack of experience and knowledge if they have been given supervision or instruction concerning use of the product in a safe way and understand the hazards involved. Children should not plug in, regulate, clean, play with or perform maintenance on this product. Children aged less than 3 years should be kept away from the product unless supervised.

## 2. FEATURES & FUNCTIONS

Not only are our radiators Lot20 compliant, we also include functions to help manage efficiency more effectively.

- **Open Windows**

This function is activated when a 4°C temperature decrease happens within a 30 minute time period. This normally occurs when a window is left open, letting warm air escape and wasting consumption. If this happens, your product will automatically activate the Anti-frost mode for 2 hours. If needed, push the on / off button to switch your product off, leave for 5 seconds and press again to turn the product on without the active Open Windows.

- **Temperature set indicator**

The temperature set indicator shows on the product display screen to indicate what level of temperature has been set in programming. A green indicator means the temperature is set between 7 - 18.5 °C. A yellow indicator is between 19 - 24.5 °C. A red indicator is between 25 - 30 °C. This indicator appears automatically and cannot be altered manually. You can see the product consumption and usage statistics in the Rointe Connect Lite app.

- **Built-in WiFi & e-life technology**

The high powered Wi-Fi module and e-life technology, built into your Rointe product, allows real-time synchronization with the Rointe Connect Lite app. Any change made via the Rointe Connect Lite app will update your product instantly for easier energy management. You won't need intermediate or additional devices. **Please note your Wi-Fi network must only be 2.4 GHz in order for the app and WiFi module in your product to work.**

## 3. INSTALLATION

We recommend using a Rointe Trusted Supplier. Find your nearest one by calling us on **0203 321 5928** or using the locator at [www.rointe.co.uk](http://www.rointe.co.uk).

**IMPORTANT:** Before installation, please locate the metal tag situated on the back of the product and note the product reference and serial number. You will need this information to register your guarantee.

**WARNING:** Do not install the product directly below a fixed socket outlet or connection box. Do not install or use outdoors. Do not install directly underneath a shelf. This product is designed for internal wall-mounted installation using the ROINTE template, installation kit and fixing items provided.



**DO NOT COVER.** Do not dry clothes or towels on the heater nor leave fabrics, magazines, spray cans, volatile substances or similar objects within 250mm of the heater.

The product should be wall-mounted in an upright position according to the minimum clearances shown opposite, using the brackets and fixings supplied.

Our products transfer heat through natural air convection. If the product is covered, this will interrupt air-flow and could cause overheating. Please do not cover the products or place any object (including furniture) directly in front of it.

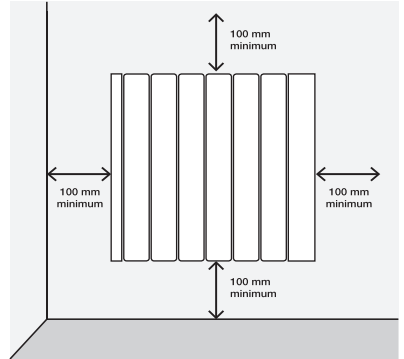

**WARNING:** The product is IP 24 rated and may be used in bathrooms, but not near baths, showers, water connections, basins etc. It can only be installed outside of zone 1 and 2. The product must not be installed where itself or the control panel is within the reach of persons in water.

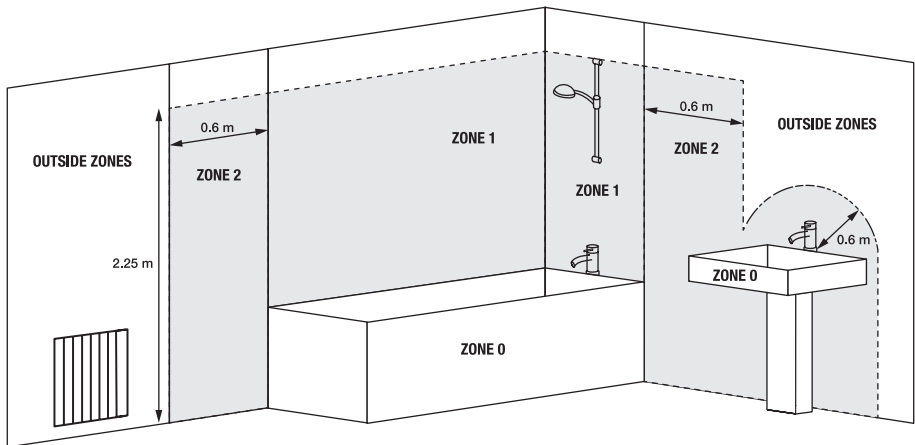

Inside the product packaging, you will find an installation kit. You will need a drill, rubber mallet, spirit level and a pencil to complete the installation.

**IMPORTANT:** Please follow these instructions carefully.

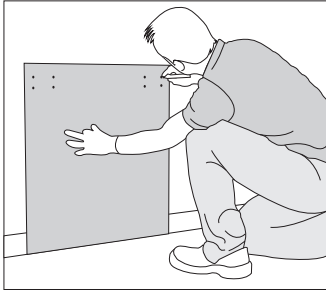

1. Remove packaging and check installation kit contains brackets, screws, rawl plugs and cardboard template.
2. Place template on the wall and mark holes for brackets and screws. Observe minimum distance requirements on the previous page.

Use the floor as a base for the template, **not** the skirting board.

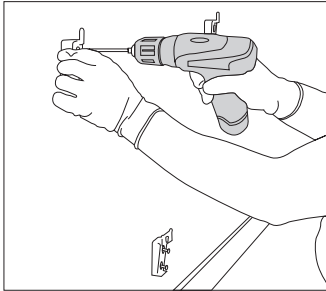

3. Remove the template and carefully drill the marked holes.
4. Fix upper brackets using the plugs and screws provided. Then fix the lower bracket.

**NOTE:** The lower bracket has a different design to the upper ones, so you can tell them apart.

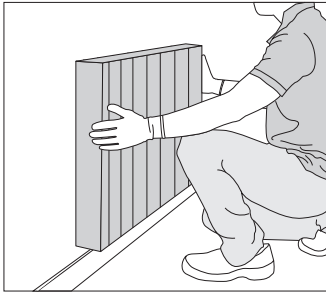

5. Slide product into fixed brackets, using a top to bottom method. Lift the product higher than the bracket and slide downwards into position.
6. Check the straightness with a spirit level and adjust brackets accordingly if needed.

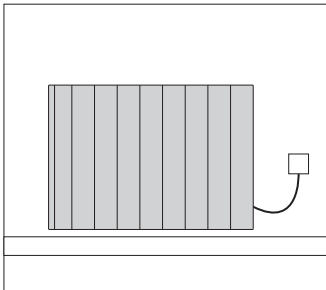





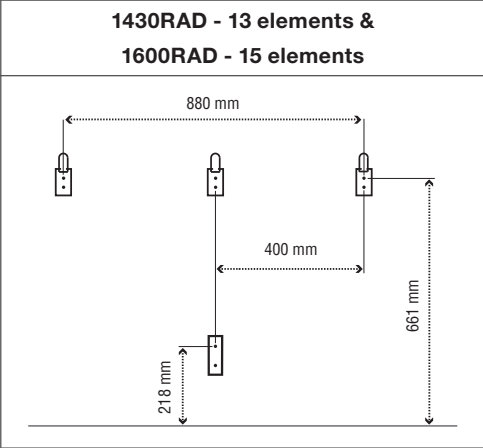
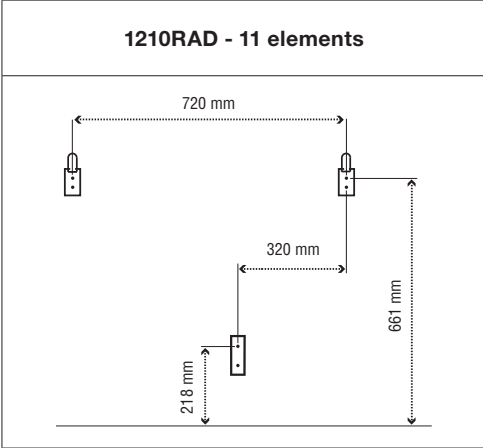
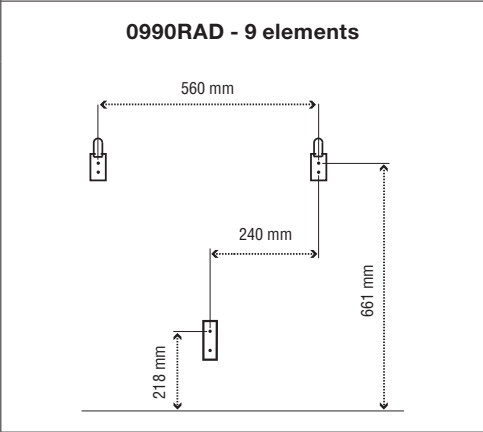
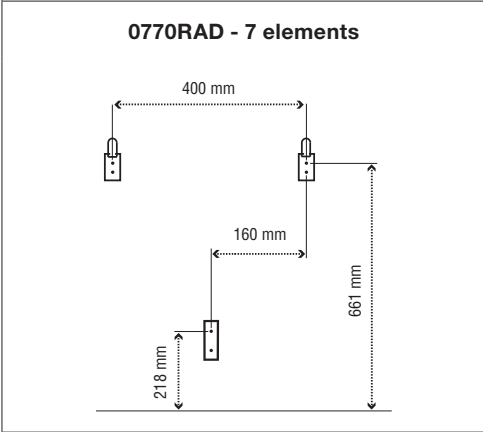
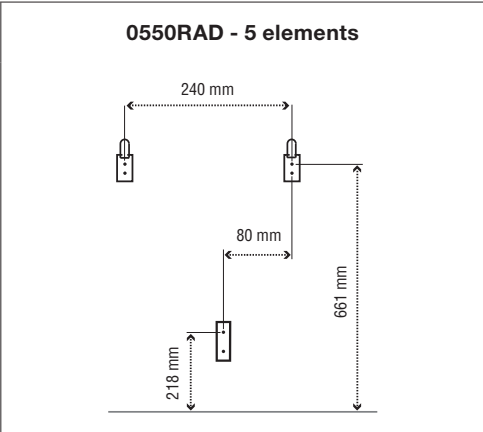
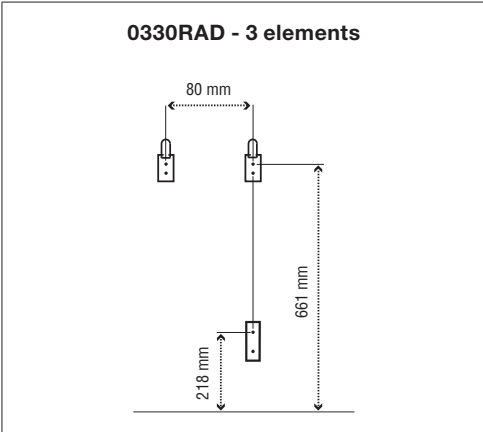



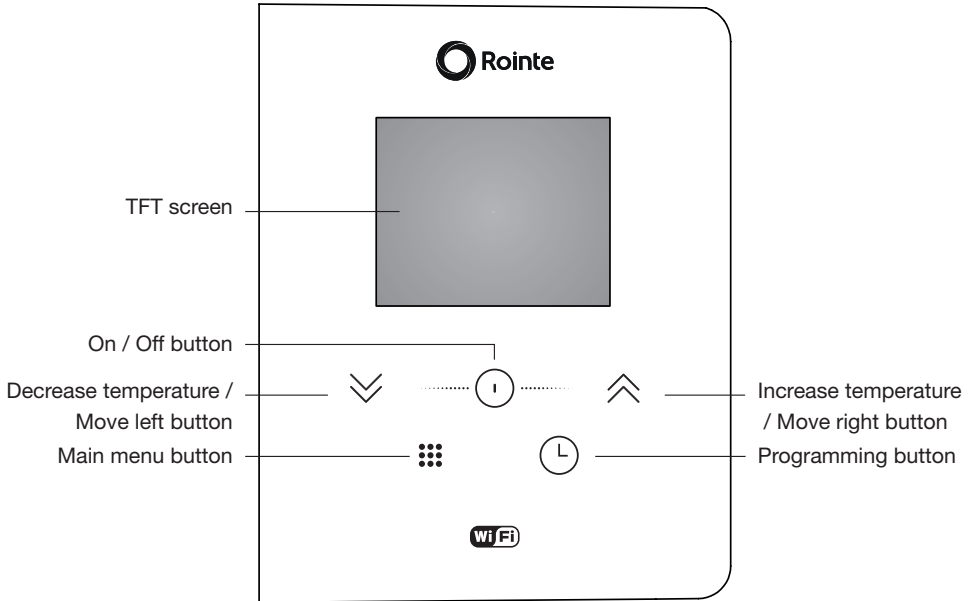





7. Connect your product to the electric supply and switch on.
8. See section 5 for operation instructions.

**IMPORTANT:** Template measurements per model



## 4. CONTROL PANEL







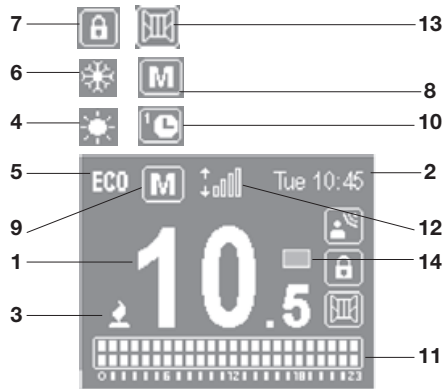





1	Selected temperature		8	Manual mode	
2	Current time and day		9	Automatic mode	
3	Heating element on		10	Preset programs mode	
4	Comfort mode		11	Hourly programming	
5	Eco mode		12	WiFi connection indicator	
6	Anti-Frost mode		13	Open Windows indicator	
7	Locked buttonpad		14	Energy consumption indicator	









## 5. OPERATION & PROGRAMMING

### 5.1. Switch on / off

To turn the product on press the  button once. To turn off press the  button again. When you turn the product on for the first time, it will ask you to set the date and time. Use the   buttons to select the correct time and press the  button to confirm. Then use the   buttons to select the correct minutes and press . Use the   buttons again to select the correct day and press the  button to confirm.

### 5.2. Select the set temperature

You can regulate the set temperature of the radiator by using the   buttons. Press the button  to increase the product temperature by 0.5 °C or the  button to decrease the temperature by 0.5 °C. The temperature ranges for each mode are as follows:

COMFORT	19 - 30 °C
ECO	7.5 - 18.5 °C
ANTI-FROST	7 °C

### 5.3. Temperature control

When the temperature in the room is lower than the selected one, the heating element is activated and the  symbol appears. The temperature control will perform an intelligently to activate and deactivate the electric current through the heating element to heat the fluid in the radiator.

#### 5.4. Lock / unlock buttonpad





The buttonpad can be locked using the control panel or the Rointe Lite App. When the buttonpad is locked, you must unlock it via the method used to lock it.



To lock / unlock the buttonpad using the product control panel, press and hold the  and  buttons together for 3 seconds.

The On/Off button will still work, even if the control panel is locked. Press the  button for 3 seconds to switch the product on or off.





#### 5.5. Configuration menu





















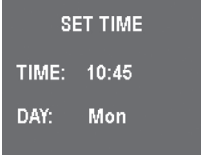

Press the  button to access the configuration menu. The available options are: Settings, Energy, WiFi and Programming mode.

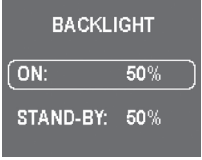
	<b>Settings</b> 	Set time
		Backlight
		Language
		Firmware
	<b>Energy</b> 	Open windows function
		Balance mode
		Adaptative mode
	<b>WiFi</b> 	On / Off
		Link device
		WiFi info
	<b>Prog. mode</b> 	On / Off
		Preset programs
		User mode
		Pilot wire (only available on request)





Use the   buttons to move between the menu options. A box will appear around the option you have selected. Press the  button to enter the submenu.













### 5.5.1. Settings menu

Press the  button to access the configuration menu. Then use the   buttons to navigate to **SETTINGS**. Press the  button to access.





	<ul style="list-style-type: none"> <li>• <b>Set the day and time</b></li> </ul> <p>To set the day or time select the <b>CLOCK</b> option.</p> <p>Use the   buttons to select the correct time and press the  button to confirm. Then use the   buttons to select the correct minutes and press the  button to confirm. Then use the   buttons to select the correct day and press the  button to confirm.</p>	
	<ul style="list-style-type: none"> <li>• <b>Adjust brightness</b></li> </ul> <p>This function allows you to adjust the brightness when the product is on or in standby.</p> <p>To adjust the brightness, select <b>BACKLIGHT</b>. With the   buttons you can turn the brightness up or down. Press the  button to confirm.</p>	
	<ul style="list-style-type: none"> <li>• <b>Language</b></li> </ul> <p>This function allows you to change the language of the product.</p> <p>To change the language, select <b>LANGUAGE</b>. Use the   buttons to select the correct one and press .</p>	
	<ul style="list-style-type: none"> <li>• <b>Firmware</b></li> </ul> <p>Press the <b>FIRMWARE</b> option to see the current software version and the release date.</p>	













### 5.5.2. Energy menu

Press the  button to access the configuration menu. Then use the   buttons to navigate to **ENERGY**. Press the  button to access.



	<ul style="list-style-type: none"> <li> <b>Open Windows</b>            Use the   buttons to select whether you want this function On / Off and press  to save.            See section 2 for more information on this function.         </li> </ul>	<div style="background-color: #444; color: white; padding: 10px; text-align: center;"> <p><b>OPEN WINDOWS</b></p> <p><input type="button" value="ON"/></p> <p><input type="button" value="OFF"/></p> </div>
	<ul style="list-style-type: none"> <li> <b>Balance</b>            This function resets your product to a temperature of 19°C in Manual mode.            Use the   buttons to select this option and press  to confirm. The screen will show 19°C in Manual mode.         </li> </ul>	<div style="background-color: #444; color: white; padding: 10px; text-align: center;"> <p>OPEN WINDOWS</p> <p><input type="button" value="BALANCE MODE"/></p> <p>ADAPTATIVE MODE</p> <p>PRESENCE DETEC.</p> </div>
	<ul style="list-style-type: none"> <li> <b>Adaptive mode</b>            This function anticipates the product start-up, so that the room temperature at the start of the selected time is equal to the set temperature at the exact time that we have established during programming. This means your product will begin heating before the time set. This ensures the temperature is at the set temperature for the start of the time selected.            To indicate that the algorithm is working, the icon will flash.            Use the   buttons to select whether you want this function On / Off and press  to save.         </li> </ul>	<div style="background-color: #444; color: white; padding: 10px; text-align: center;"> <p><b>ADAPTATIVE MODE</b></p> <p><input type="button" value="ON"/></p> <p><input type="button" value="OFF"/></p> </div>



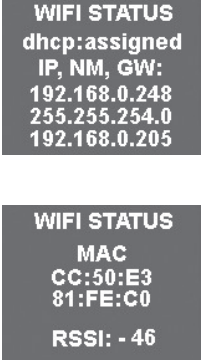





### 5.5.3. WiFi menu

Press the  button to access the configuration menu. Then use the   buttons to navigate to **WiFi**. Press the  button to access.

	<ul style="list-style-type: none"> <li> <b>WiFi status</b>                      The <b>WiFi STATUS</b> option allows you to activate or deactivate the product WiFi connection.                      Use the   buttons to select On / Off and press  to save.                 </li> </ul>	
	<ul style="list-style-type: none"> <li> <b>Link device</b>                      The <b>LINK DEVICE</b> option generates a WiFi network to connect your product.                      When you select <b>LINK DEVICE</b>, the following screen will appear where you will be given the name of the network and the password.                      For more information on the pairing process, see section 6.                      Use the   buttons to select this option and press  to confirm.                 </li> </ul>	
	<ul style="list-style-type: none"> <li> <b>WiFi info</b>                      The <b>WiFi INFO</b> option allows you to view information on the network status.                      When you select <b>WiFi INFO</b>, the following screen appears where you can see the IP, NM and GW.                      Use the  button to see more information.                 </li> </ul>	

### 5.5.4. Prog. Mode

To change the status of your product from **MANUAL to AUTO** or vice versa, make a quick press of the  button. If you want to start programming your product, make a long press of the  button. To see all the options available for programming your radiator, select the option **PROG. MODE** in the main menu. The screen will show the following options:

	<ul style="list-style-type: none"> <li>• <b>Mode</b></li> </ul> <p>From the <b>MODE</b> menu, select the operating mode you require: <b>MANUAL</b> or <b>PROGRAMMING</b>.</p> <p>Use the   buttons to select manual or programming and press  to confirm.</p>	<div style="background-color: #333; color: white; padding: 5px;"> <p style="text-align: center; margin: 0;">MODE</p> <div style="border: 1px solid white; border-radius: 5px; padding: 2px; margin: 2px; text-align: center; color: white;">MANUAL</div> <div style="border: 1px solid white; border-radius: 5px; padding: 2px; margin: 2px; text-align: center; color: white;">PROGRAMMING</div> </div>
	<ul style="list-style-type: none"> <li>• <b>Preset heating programs</b></li> </ul> <p>From the <b>PRE-PROGRAMS</b> menu you can select a preset heating program to use. There are 4 available. Use   to select between the different programs and press  to confirm.</p>	<div style="background-color: #333; color: white; padding: 5px;"> <p style="text-align: center; margin: 0;">PRE-PROGRAMS</p> <div style="border: 1px solid white; border-radius: 5px; padding: 2px; margin: 2px; text-align: center; color: white;">PRE-PROG 1</div> <div style="border: 1px solid white; border-radius: 5px; padding: 2px; margin: 2px; text-align: center; color: white;">PRE-PROG 2</div> <div style="border: 1px solid white; border-radius: 5px; padding: 2px; margin: 2px; text-align: center; color: white;">PRE-PROG 3</div> <div style="border: 1px solid white; border-radius: 5px; padding: 2px; margin: 2px; text-align: center; color: white;">PRE-PROG 4</div> </div>

### Available pre-programs













COMFORT	ECO	OFF	
---------	-----	-----	--











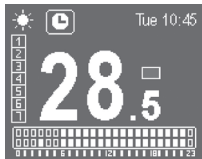

PRE-PROGRAM 1																								
	0	1	2	3	4	5	6	7	8	9	10	11	12	13	14	15	16	17	18	19	20	21	22	23
Mon-Fri																								
Sat-Sun																								

PRE-PROGRAM 2																								
	0	1	2	3	4	5	6	7	8	9	10	11	12	13	14	15	16	17	18	19	20	21	22	23
Mon-Fri																								
Sat-Sun																								



PRE-PROGRAM 3																								
	0	1	2	3	4	5	6	7	8	9	10	11	12	13	14	15	16	17	18	19	20	21	22	23
Mon-Sun																								

PRE-PROGRAM 4																								
	0	1	2	3	4	5	6	7	8	9	10	11	12	13	14	15	16	17	18	19	20	21	22	23
Mon-Fri																								
Sat-Sun																								

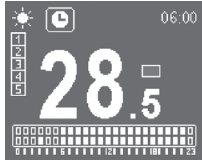
	<ul style="list-style-type: none"> <li>• <b>User program</b></li> </ul> <p>This mode allows the user to make their own programming. There are 2 ways to start editing the programming:</p> <ol style="list-style-type: none"> <li>1. Do a long press on the  button.</li> <li>2. Enter the submenu <b>USER PROGRAM</b> from the main menu.</li> </ol> <p>Then follow the steps below.</p>	
	<p><b>STEP 1</b></p> <ol style="list-style-type: none"> <li> <p><b>1. Select the COMFORT temperature:</b></p> <p>Temperature range <b>19 – 30 °C</b></p> <p>Use the   buttons to select the desired Comfort temperature.</p> <p>Press  to confirm.</p> </li> <li> <p><b>2. Select the ECO temperature:</b></p> <p>Temperature range: <b>7.5 – 18.5 °C</b></p> <p>Use the   buttons to select the desired Eco temperature.</p> <p>Press  to confirm.</p> </li> <li> <p><b>3. Select between ANTI-FROST or OFF:</b></p> <p>Temperature range: <b>7 °C / OFF</b></p> <p>Use the   buttons to select the ANTI-FROST or OFF.</p> <p>Press  to confirm.</p> </li> </ol>	





	<p style="text-align: center;"><b>STEP 2</b></p>	<p><b>Select the days to be programmed</b></p> <p>Start on Day 1 (Monday).</p> <p>Press the  button to include this day in your programming. Press the  button again to exclude.</p> <p>Use the   buttons to move to the next day and repeat for all days of the week.</p> <p>The selected days will be highlighted by a box on the screen.</p> <p>Once you have reached Day 7, press the  button to advance to the next step.</p>	
	<p style="text-align: center;"><b>STEP 3</b></p>	<p><b>Select the hour and mode to be programmed</b></p> <p>Start on 0h (midnight).</p> <p>Press the  button to select <b>ECO</b>, <b>COMFORT</b> or <b>ANTI-FROST/OFF</b> for that hour. Press  to move to the next hour and repeat.</p> <ul style="list-style-type: none"> <li>• The upper right of the screen shows the hour you are programming.</li> <li>• The left side shows the selected days.</li> <li>• The bottom programming bar indicates: <ul style="list-style-type: none"> <li>-Comfort mode: 2 shaded squares </li> <li>-ECO mode: lower shaded square </li> <li>-ANTI-FROST/OFF: 2 empty squares </li> </ul> </li> </ul> <p>Once you reach 23:00 hours, press  to complete the programming.</p>	



	<ul style="list-style-type: none"> <li> <b>Pilot wire</b>                      This option activates the pilot wire mode for those products that are connected to a control panel by means of a pilot wire.                      The product will be managed by the external pilot wire control unit to which it is connected.                      Use <math>\sphericalangle</math> <math>\sphericalangle</math> to select this option and press <math>\odot</math> to confirm.                 </li> </ul>	
---	--	--

## 6. WIFI PAIRING

Selecting the option “pair the product” will create its own network to which you can connect your device.

<ul style="list-style-type: none"> <li> <b>Starting process</b>                      The following screen will show the data of the created network (NET) and the password (PIN) for the product you want to pair.                 </li> </ul>	
<ul style="list-style-type: none"> <li> <b>Connection</b>                      When the smartphone is connected to the radiator network, the following display will appear:                 </li> </ul>	
<ul style="list-style-type: none"> <li> <b>Product configuration</b>                      When the product has received the configuration from the smartphone, it will start processing and display the following screen:                 </li> </ul>	
<ul style="list-style-type: none"> <li> <b>End of the pairing process</b>                      This screen indicates to the user that the product has processed the information received. After displaying this screen for 2 seconds the product will restart.                 </li> </ul>	

## 7. MAINTENANCE & CLEANING

The product does not require regular maintenance. We do, however, recommend that all parts of the product are kept clean (behind, underneath, along the upper fins etc.). Clean the aluminium with a soft, damp cloth and pH-neutral soap. Clean the control panel with a soft, dry cloth.

**WARNING:** Disconnect the product from the power supply before any cleaning or maintenance.

**WARNING:** Do not use any abrasive product on the aluminium, such as (but not limited to) chemicals, rough cloths, hard bristled brushes or wire/steel wool.

## 8. EUROPEAN DIRECTIVE (WEEE) 2012/19/UE

Under the European Directive 2012/19/UE on Waste Electrical and Electronic Equipment (WEEE), this product cannot be treated as household waste. Instead it must be separated to optimize the recovery and recycling of all of the components and materials to reduce the impact on human health and the environment. The symbol of the container crossed out over a horizontal line is marked on all of ROINTE products to remind the consumer of the obligation to separate them on disposal. The consumer should contact their local authority or council office, or original point of sale to learn about the correct method of disposal for this product.

## 9. GUARANTEE

There are certain terms and conditions on this ROINTE product. These conditions comply with all the rights construed within national legislation, as well as any additional rights and guarantees, which are offered by ROINTE. Please ensure that you register your product guarantee at [www.rointe.co.uk](http://www.rointe.co.uk).

Any incident you might detect with your product can be sorted by the product seller or by ROINTE. Please contact ROINTE by telephoning **0203 321 5929** or send an email to **support@rointe.co.uk**, through which we will instruct you on how to solve the incident.

**You will need to state the product reference and serial number (located on the metal tag with the product) and the type of incident when contacting ROINTE. In addition, please attach a copy of the product invoice and/or proof of purchase that indicates the date on which the product was sold.**

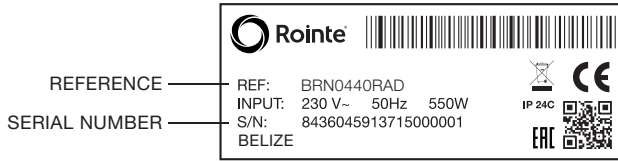

## 9.1 Terms & conditions

1. ROINTE guarantees there are no material defects of design or manufacture at the time of original purchase. ROINTE guarantees the aluminium body for 120 months and electric plus electronic components for 24 months for this product only, provided it has not been modified in any way.

2. If during the guarantee period, the product does not work correctly under normal use, and any design, material or manufacturing defect is found, ROINTE will repair or substitute the product as it sees fit, in accordance with the terms and conditions as follows:

2.1. The guarantee is only applicable if the original guarantee is issued by the seller and when the said guarantee has been registered with ROINTE correctly, including product reference, series number (marked on the product's metal tag), purchase date and proof of purchase. The product guarantee can be registered on our website at [www.rointe.co.uk](http://www.rointe.co.uk) or can be sent via email to [support@rointe.co.uk](mailto:support@rointe.co.uk) within 90 days of installation. ROINTE reserves the right to reject the guarantee when this information has been removed or modified after the original product purchase.

2.2. The guarantee is only applicable if the product has been installed by a competent person in accordance with this installation manual and all current regulations at the time of installation.

2.3. The guarantee is only applicable to those cases that concern material, design and manufacturing defects, and under no circumstances covers damage to the product for the following reasons:

i) Damage caused by negligence and / or misuse of the product, i.e. used for other purposes that are not construed as its normal use or for not respecting instructions of use and maintenance given by ROINTE, as well as incorrect installation or use of the product that may not comply with the current technical standards of safety.

ii) Corrosion of any part of the product caused by direct exposure to salt-water. When the product is installed less than 200m from the coast, the guarantee period for damages caused by corrosion will be reduced by 50%.

iii) Any unauthorised modification of the product or repairs of the product carried out by third parties or unauthorised persons, or opening of the product by third parties or unauthorised persons.

iv) Any accidents that are deemed outside the control of ROINTE, such as (but not

limited to): lightning, fires, floods, natural disasters, public disorder, atmospheric or geologic phenomena etc.

v) Faults that result from incorrect installation. Guidance can be found from Rointe and in this installation manual. If in doubt, please contact ROINTE.

2.4. Any repairs or substitutions completed as part of this guarantee service do not allow extension periods or new periods of guarantee i.e. your guarantee will not be extended should a repair or substitution of this product take place.

2.5. Any repairs or substitutions covered under this guarantee must be parts that are functionally equivalent. The defective parts or parts removed or replaced shall become the property of ROINTE and should be returned as such.

2.6. The product must be installed in a way that allows access for ROINTE technicians or authorised persons should they need to gain access to the product for repair or maintenance. The user/client is responsible for any costs or organisation required to provide access to the products for repair and/or substitution.

3. The ROINTE Technical Support department will advise you if you need to purchase any parts not covered under this guarantee or out of guarantee.

4. This guarantee will be invalid if the product: has been manipulated, modified and/or repaired in any way and/or by unauthorised persons. This guarantee will also be invalid if the product is not correctly installed.

5. This guarantee is not transferable and does not include claims due to damage by lime scale or frost.

6. Proof of purchase will be required by ROINTE for any claim.

7. This guarantee does not affect your statutory rights.

8. This guarantee does not affect the buyer's legal rights stipulated in current national legislation, nor affects those rights against the distributor or installer that could come forth in compliance with the purchase contract.

9. In the absence of applicable national legislation, this guarantee shall prevail and may be construed as the buyer's only protection. ROINTE, its offices, employees, distributors and installers will not be held responsible for any accidental damage that emerges due to infringement of any rules implicitly related to this product.

10. Check the EULA conditions (supplied with the product) for information about the legal agreement you accept when installing a ROINTE Belize product.

**For help about the product or guarantee, please contact ROINTE by phoning 0203 321 5929 or send an email to [support@rointe.co.uk](mailto:support@rointe.co.uk).**

## 9.2 How to register your product guarantee

**IMPORTANT:** It's important to register your ROINTE product as part of our guarantee service, in case you wish to make a claim.

You can register your ROINTE product in the following ways:

### **WEBSITE**

1. Go to [www.rointe.com/uk/register-your-guarantee/](http://www.rointe.com/uk/register-your-guarantee/).
2. Login to your existing account or create a new account if you need to.
3. Click on **"My products"**.
4. Enter your **product reference** (alphanumeric and in upper case).
5. Enter your **serial number** (26 digits located on the metal tag on your product and starts with 843).
6. Upload your **proof of purchase**, such as invoice in PDF, JPEG or PNG format. This is not mandatory but by doing so you ensure your guarantee period is accurate.
7. Click **"Register"**.
8. **Congratulations! Your product is now registered.**

### **EMAIL**

1. Send an email to [support@rointe.co.uk](mailto:support@rointe.co.uk) with the following information:
  - **Customer name**
  - **Address and postcode**
  - **Telephone number and email address**
  - **Product reference** (as described above)
  - **Serial number** (as described above)
  - **Product purchase date and proof of purchase** (as described above).
2. Our Technical Support team will confirm your product registration and request any additional information needed via email.

### **POST**

1. Post the information listed in the EMAIL section above to:
  - **INDUSTRIAS ROYAL TERMIC, S.L. t/a Rointe UK, C/E Parcela 43, 30140, Santomera (SPAIN)**
2. Please ensure you obtain proof of posting.

## 10. ERP DIRECTIVE (EU) 2015/1188

ITEM	SYMBOL	UNIT	0330RAD	0550RAD	0770RAD	0990RAD	1210RAD	1430RAD	1600RAD
<b>HEAT OUTPUT</b>									
Nominal heat output	$P_{nom}$	kW	0.33	0.55	0.77	0.99	1.21	1.43	1.6
Minimal heat output	$P_{min}$	kW	n/a	n/a	n/a	n/a	n/a	n/a	n/a
Maximum continuous heat output	$P_{max,c}$	kW	0.33	0.55	0.77	0.99	1.21	1.43	1.6
<b>AUXILIARY ELECTRICITY CONSUMPTION</b>									
At nominal heat output	$e_{l,MAX}$	kW	0.33	0.55	0.77	0.99	1.21	1.43	1.6
At minimum heat output	$e_{l,MIN}$	kW	0.33	0.55	0.77	0.99	1.21	1.43	1.6
In standby mode	$e_{l,SB}$	kW	0.002	0.002	0.002	0.002	0.002	0.002	0.002
<b>TYPE OF HEAT OUTPUT/ROOM TEMPERATURE CONTROL (SELECT ONE)</b>									
Single-level heat output, no internal temperature control		-	-	-	-	-	-	-	-
Two or more manual levels, without internal temperature control		-	-	-	-	-	-	-	-
Internal temperature control by mechanical thermostat		-	-	-	-	-	-	-	-
With electronic interior temperature control		-	-	-	-	-	-	-	-
Electronic indoor temperature control and daily timer		-	-	-	-	-	-	-	-
Electronic indoor temperature control and weekly timer		-	✓	✓	✓	✓	✓	✓	✓
<b>OTHER CONTROL OPTIONS (MULTIPLE SELECTIONS POSSIBLE)</b>									
Interior temperature control with presence detection		-	-	-	-	-	-	-	-
Interior temperature control with detection of open windows		-	✓	✓	✓	✓	✓	✓	✓
With remote control / distance option		-	✓	✓	✓	✓	✓	✓	✓
With adaptive start-up control		-	✓	✓	✓	✓	✓	✓	✓
With operating time limitation		-	✓	✓	✓	✓	✓	✓	✓
With black lamp sensor		-	-	-	-	-	-	-	-
<b>SEASONAL SPACE HEATING ENERGY EFFICIENCY</b>	$\eta_s$	-	<b>39.0%</b>	<b>39.0%</b>	<b>39.0%</b>	<b>39.0%</b>	<b>39.0%</b>	<b>39.0%</b>	<b>39.0%</b>

11. TECHNICAL SPEC

MODEL	0830RAD	0550RAD	0770RAD	0890RAD	1210RAD	1430RAD	1600RAD
No. Heating Elements	3	5	7	9	11	13	15
<b>MATERIALS</b>							
High purty aluminium body	✓	✓	✓	✓	✓	✓	✓
Control panel with touch keyboard	✓	✓	✓	✓	✓	✓	✓
<b>DIMENSIONS, WEIGHTS &amp; FINISHES</b>							
Width (mm)	340	500	660	820	980	1,140	1,300
Height (mm)	575	575	575	575	575	575	575
Depth (mm)	95	95	95	95	95	95	95
Installed Depth (mm)	120	120	120	120	120	120	120
Weight (kg)	8	12	16	20	24	28	32
Finish	White RAL 9010						
<b>ELECTRICAL CHARACTERISTICS</b>							
Nominal Power (W)	330	550	770	990	1,210	1,430	1,600
Voltage (V)	230 ~V	230 ~V	230 ~V	230 ~V	230 ~V	230 ~V	230 ~V
Current (A)	1.5	2.4	3.4	4.3	5.3	6.2	7.0
Power per Element (W)	110	110	110	110	110	110	110
<b>INSTALLATION &amp; SAFETY</b>							
Safety thermostat	✓	✓	✓	✓	✓	✓	✓
Installation kit	✓	✓	✓	✓	✓	✓	✓
Protection Grade	IP24	IP24	IP24	IP24	IP24	IP24	IP24
<b>EAN CODES</b>	8435556138723	8435556138730	8435556138747	8435556138754	8435556138761	8435556138778	8435556138785



If you have any questions or need help, please contact us:

[www.rointe.co.uk/technical-support](http://www.rointe.co.uk/technical-support)

[support@rointe.co.uk](mailto:support@rointe.co.uk)

0203 321 5929

Monday to Friday from 8.00 am to 5.00 pm.

**Rointe United Kingdom**

Hampton Business Park, Club Way,  
Peterborough PE7 8JA  
T. 0203 321 5928

**Rointe Ireland**

Blackrock, County Louth  
T. 01 553 0523

**Rointe España & Portugal**

P.I. Vicente Antolinos - C/ E, p. 43, 30140 Murcia  
T. 902 158 049

**Rointe France**

6 Rue Duret, 75116 Paris  
T. 01 73 05 70 01



Copyright © Rointe Heating 2020. All rights reserved. As part of our continuous improvement policy, we reserve the right to alter or modify any product or specifications without notice. This also applies to products already on order provided that such alterations can be made without subsequent changes to specifications already agreed. We cannot accept responsibility for any errors in catalogues or other printed materials.

IMBRUK21V2